

# MULTI-STAGE INCUBATOR

Tel: (626)823-4815 Fax: (626)698-1638

Email: sales@microwavetown.com

Web: <http://www.microwavetown.com/poultry equipments>

## INCUBATION EQUIPMENT



**EIF(XDZ)-90720 TUNNEL INCUBATOR**

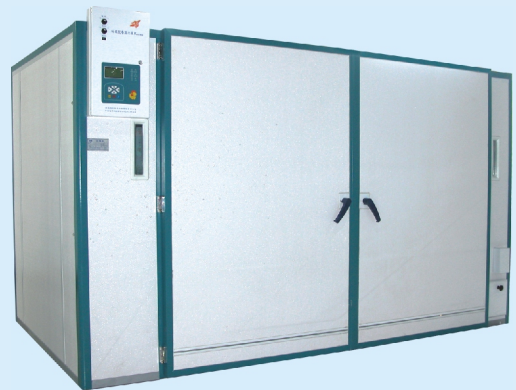

**AIR CIRCULATION HATCHER**

### Major parameters of EIF(XDZ)-90720:

Capacity: 90720

Quantity of egg trolley: 12

Apparent power: 7.0 or 9.7 KW

Power supply requirement: 380/220 VAC 50 Hz

Insulation resistance:  $\geq 2M$

Dimensions: 8340×3120×2600 (mm)  
27'4"×10'3"×8'6"

Temperature control range: 31.5~39°C  
88.7~102.2°F

Humidity control range: 40~80% RH

Egg Turnover timing: 60 min

Egg Turnover angle:  $43 \pm 2^\circ$

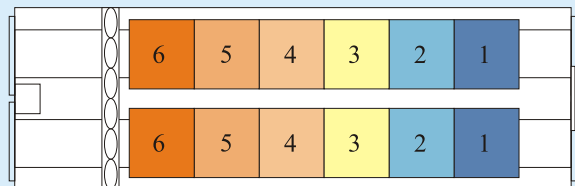

ILLUSTRATION OF THE TEMPERATURE-GRADIENT INCUBATION IN BATCHES

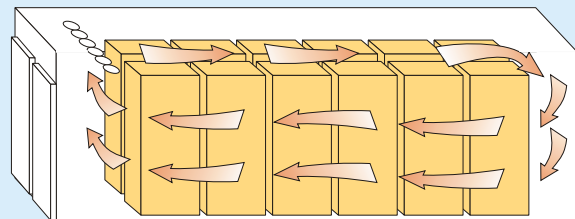

ILLUSTRATION OF THE AIRFLOW CIRCULATION INSIDE THE CABINET



FAN SYSTEM



TEMPERATURE SENSOR

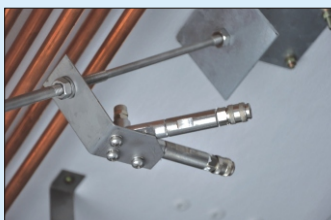

SPRAYING NOZZLE



HEATING RODS



TROLLEY  
(EGG CAPACITY 7560)

## SPECIFICATIONS, CONSTRUCTION AND DIMENSIONS OF EIF (DM/DZ/DMS)-19200/12096 BOX-TYPE INCUBATOR

FRONT VIEW

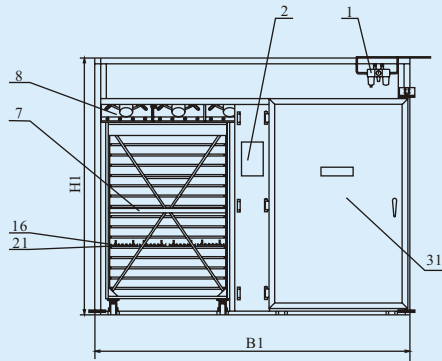

SIDE VIEW

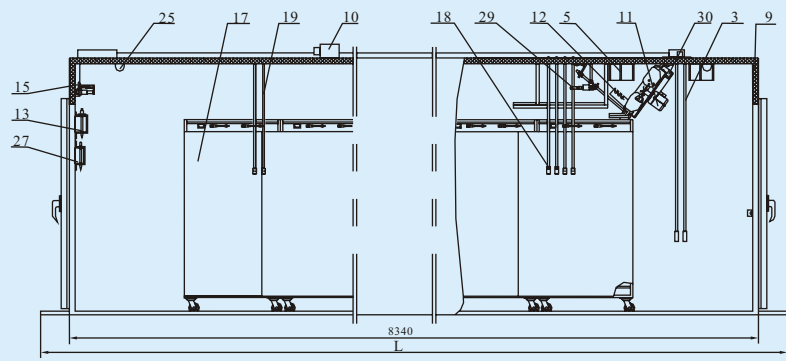

TOP VIEW

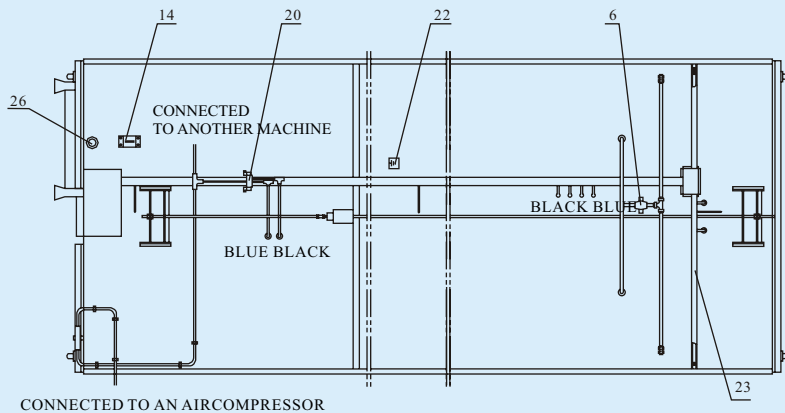
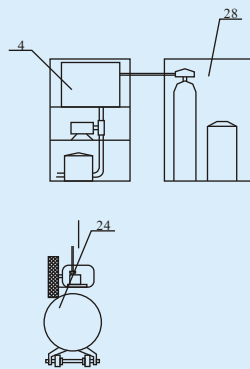

No.	Description	Qty.	No.	Description	Qty.	No.	Description	Qty.
1	Air supply triplet	1	12	Heating rod	3	23	Wiring duct	1 set
2	EIXDZ Controlling cabinet	1	13	Thermostat	1	24	Air compressor	equipped by customers
3	Intelligent temperature controlling sensor	2 (optional)	14	Cable clip ass'y	1	25	Water-proof lamp	3
4	Tunnel incubator water supply system:	1 (optional)	15	Temperature and humidity sensors	1	26	Ring 4-75TH	1
5	Tunnel incubator water cooling system:	1 (optional)	16	Egg Holder	2	27	Incubation thermometer 30-40	1
6	Humidifying electromagnetic valve	1	17	Trolley curtain	12	28	Water-softening system	1 (optional)
7	Model 7560 trolley	12	18	Egg turnover detection line	2	29	Humidifying nozzle	4
8	Fan bracket	1	19	Egg turnover AirInlet	4	30	Fan detection	6
9	Tunnel incubator box	1	20	Egg turnover electromagnetic valve	1	31	Door	4
10	Damper motor (case)	1	21	Setter tray with capacity of 42 (36)	1			
11	Motor fan	6	22	Grounding tag	1			

SPECIFICATION		DIMENSION (LxBxH)mm	CAPACITY	Specification of trolley (capacity/tier/quantity/dimension)	Specification of egg tray (capacity/quantity/dimension)	APPARENT POWER
SETTER	EIFXDZ-90720	8450×3122×2555	90720	7560\15\12\1250×1000×2020	42\12\306×292×75	7.0 or 9.7
HATCHER	EICXDH-15120	3360×1950×990	15120	2520\15\6\1307×392×205	168\3\1275×360×120	4.62

Tel: (626)823-4815 Fax: (626)698-1638

Email: sales@microwavetown.com

Web: <http://www.microwavetown.com/poultry equipments>