



2.4mm Connector Series

Performance Features

Nominal Impedance: 50Ω

Frequency Range: DC-50GHz

VSWR: DC-50GHz... 1.15:1 (Max)

Durability: 500 Cycles

Operating Temperature: -60°C~+165°C

Materials/Finishes

Housing: Type 303 Stainless Steel - Polished & Passivated

Center Contact: Beryllium Copper Plated Gold

Insulators:PEI

Interfaces: Per MIL-STD-348A

Interface Standards

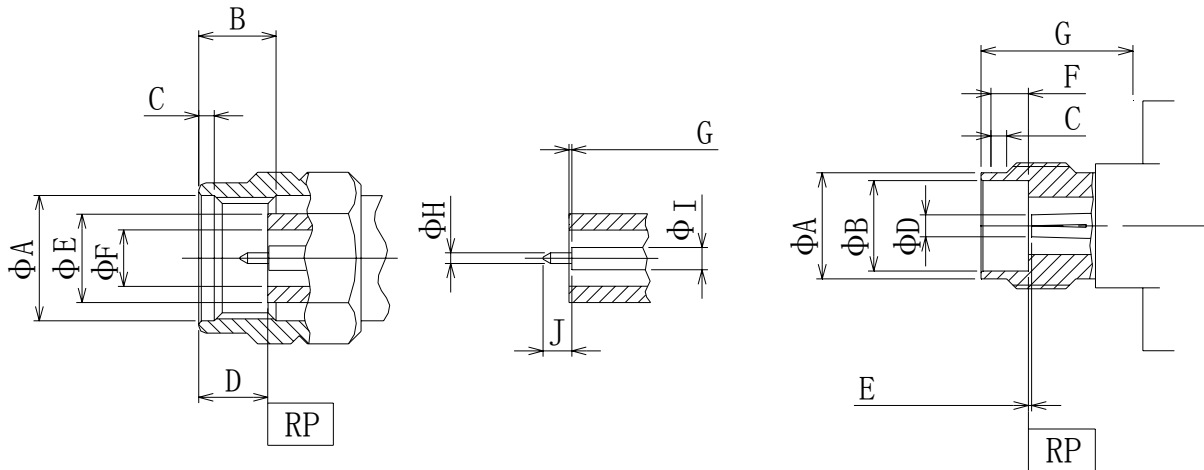

2.4mm Male (mm)		
LTR	MINIMUM	MAXIMUM
A	7.05	7.15
B	4	
C	0.8	
D	1.7	1.9
E	4.725	4.750
F	2.385	2.415
G	0	0.055
H	0.49	0.51
I	1.032	1.052
J	1.305	1.45

2.4mm Female (mm)		
LTR	MINIMUM	MAXIMUM
A	5.7	5.9
B	4.770	4.795
C	1.4	1.6
D	1.12	1.14
E	0	0.055
F	3	3.08
G	6.4	

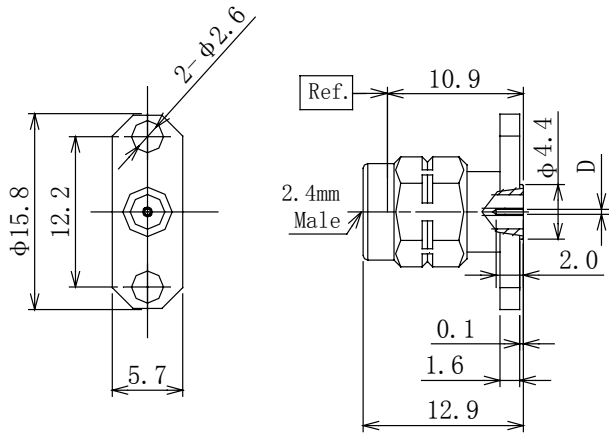

P/N	D
D371S12F04	0.012 inch/0.30mm
D371S15F04	0.015 inch/0.38mm
D371S18F04	0.018 inch/0.46mm
D371S20F04	0.020 inch/0.51mm

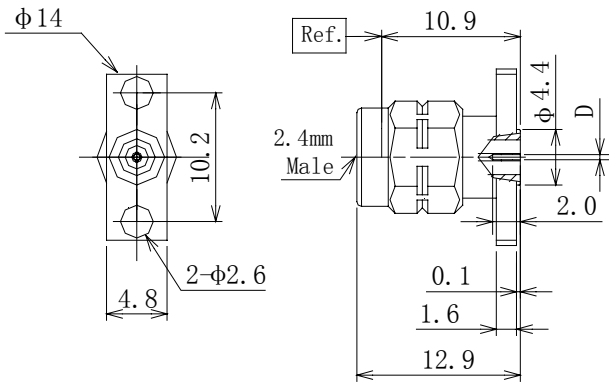

P/N	D
D371S12F05	0.012 inch/0.30mm
D371S15F05	0.015 inch/0.38mm
D371S18F05	0.018 inch/0.46mm
D371S20F05	0.020 inch/0.51mm

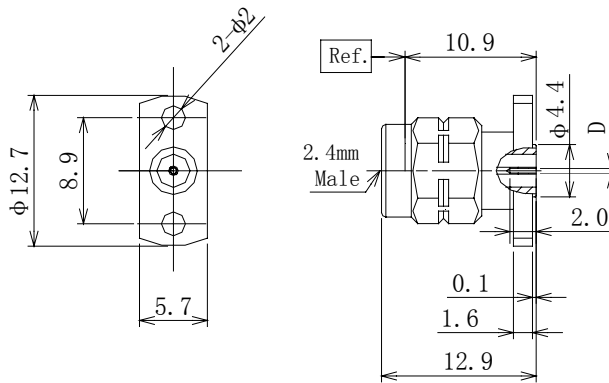

P/N	D
D371S12F06	0.012 inch/0.30mm
D371S15F06	0.015 inch/0.38mm
D371S18F06	0.018 inch/0.46mm
D371S20F06	0.020 inch/0.51mm