



2.92mm Connector Series

Performance Features

Nominal Impedance: 50Ω

Frequency Range: DC-40GHz

VSWR: DC-40GHz... 1.15:1 (Max)

Durability: 500 Cycles

Operating Temperature: -60°C~+165°C

Materials/Finishes

Housing: Type 303 Stainless Steel - Polished & Passivated

Center Contact: Beryllium Copper Plated Gold

Insulators:PEI

Interfaces:PER MIL-STD-348A

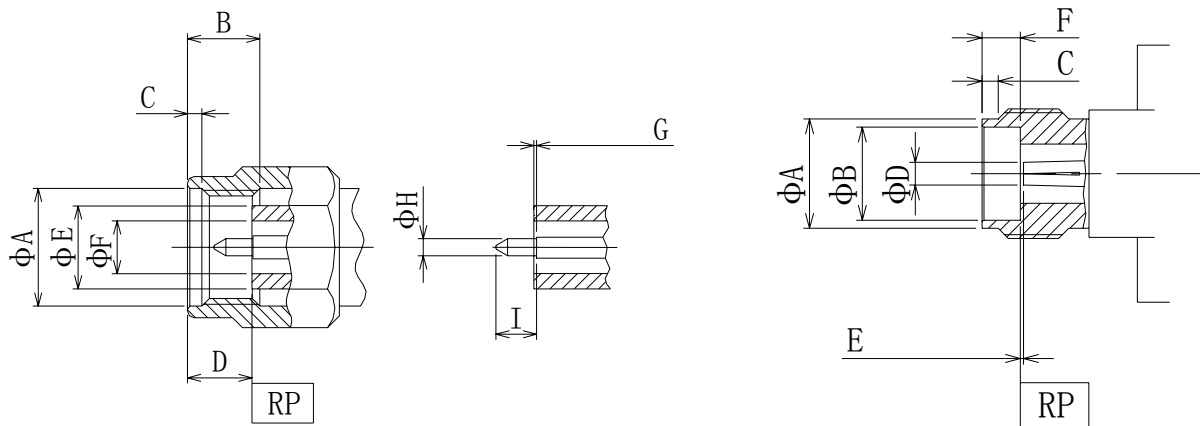

2.92mm Male (mm)		
LTR	MINIMUM	MAXIMUM
A	6.5	6.6
B	4	
C	0.8	
D	2.82	3.18
E	4.55	4.58
F	2.90	2.94
G	0	0.06
H	0.920	0.934
I	1.295	1.450

2.92mm Female (mm)		
LTR	MINIMUM	MAXIMUM
A	5.324	5.400
B	4.60	4.63
C	0.8	0.9
D	1.26	1.28
E	0	0.078
F	1.855	1.993

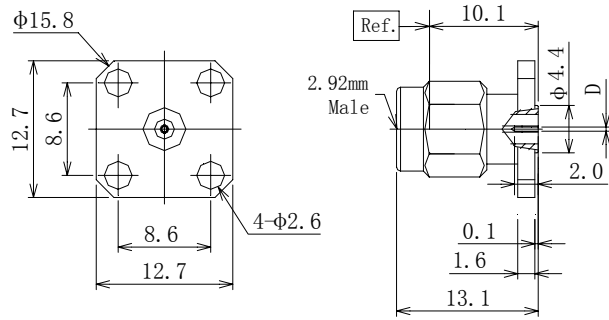

P/N	D
D361S12F01	0.012 inch/0.30mm
D361S15F01	0.015 inch/0.38mm
D361S18F01	0.018 inch/0.46mm
D361S20F01	0.020 inch/0.51mm

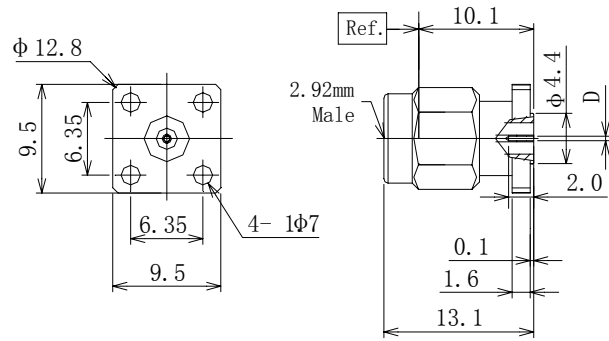

P/N	D
D361S12F02	0.012 inch/0.30mm
D361S15F02	0.015 inch/0.38mm
D361S18F02	0.018 inch/0.46mm
D361S20F02	0.020 inch/0.51mm

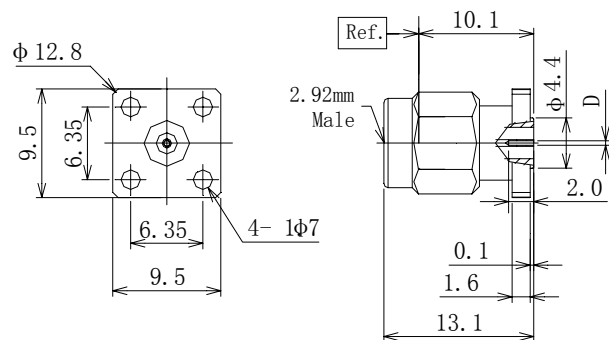

P/N	D
D361S12F03	0.012 inch/0.30mm
D361S15F03	0.015 inch/0.38mm
D361S18F03	0.018 inch/0.46mm
D361S20F03	0.020 inch/0.51mm